

ИНТЕРЬЕРНЫЙ ДЕКОР

ДЛЯ СТЕН И ПОТОЛКОВ



ПЕРФЕКТ *PLUS*

Содержание

1. P 46

2. P 128

3. P 134

4. P 157

Карнизы	4
Молдинги	10
Напольные плинтусы	22
Угловые элементы	30
Профили под подсветку	32
Дверное обрамление	36
Декоративные панели	40
Клей	52
Монтаж	54
Инструмент	56

1. P 108

2. P 32

3. P 122

Коллекция архитектурного декора «Перфект Плюс»

открывает безграничный простор для создания индивидуального дизайна, преображающего пространство внутри и снаружи. В ней представлены элементы всех архитектурных стилей от классики до хайтек.

Изделия изготовлены из новейшего высокотехнологичного и экологически чистого материала – ударопрочного полимера высокой плотности. Декоративные элементы, применяемые для оформления интерьера и фасада, сочетают в себе высочайшее качество и исключительную долговечность.

ГЛАВНЫЕ ДОСТОИНСТВА КОЛЛЕКЦИИ «ПЕРФЕКТ ПЛЮС»:



Экологичность
и безопасность



Широкая сфера применения
(могут использоваться для
декорирования помещений
и фасадов зданий)



Прочность (улучшенная
ударопрочность и повышенная
плотность изделий)



Простота монтажа



Большой ассортимент
и широко-функциональные
решения



Абсолютная влагостойкость
(100%-я влагостойкость)



Отсутствие поперечной
и линейной усадки











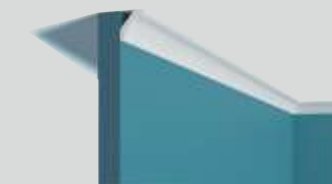

Легко окрашивается акриловыми
и водно-дисперсионными
красками

Карниз создает визуально привлекательный переход от стены к потолку



КАРНИЗЫ

ЭЛЕМЕНТЫ ДЕКОРА

 P02 1,9 x 1,2 x 200 см	 P26 1,9 x 1,9 x 200 см	 P38 2 x 2 x 200 см
 P164 2 x 2 x 200 см	 P09 2,1 x 1,4 x 200 см	 P65 2,2 x 3,2 x 200 см
 P34 2,5 x 1,5 x 200 см	 P87 2,5 x 4 x 200 см	 P36 2,9 x 2 x 200 см
 P37 3 x 3 x 200 см	 P51 3,4 x 3,1 x 200 см	 P24 3,9 x 2,4 x 200 см



P17
6,5 x 6,9 x 200 см



P96
6,8 x 4,6 x 200 см



P57
7 x 5 x 200 см



P102
10 x 6,2 x 200 см



P99
10 x 10 x 200 см



P16
11 x 12,2 x 200 см



P44
7,6 x 7,6 x 200 см



P30
7,8 x 8,5 x 200 см



P94
7,8 x 6 x 200 см



P03
11,2 x 11,4 x 200 см



P91
12 x 5,5 x 200 см



P103
12 x 7,4 x 200 см



P92
8 x 4,3 x 200 см



P46
8,5 x 8,8 x 200 см



P143
9 x 6,5 x 200 см

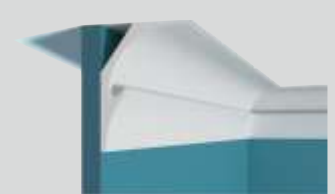

P177
12 x 9 x 200 см

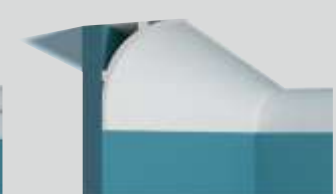

P149
12 x 10 x 200 см



P101
13 x 4,5 x 200 см



P90
9,7 x 5 x 200 см



P08
9,7 x 8,4 x 200 см



P79
10 x 5,5 x 200 см



P100
13 x 13 x 200 см



P104
14 x 8,6 x 200 см



Молдинг – один из самых распространенных видов лепного декора, который отлично впишется в любую стилистику

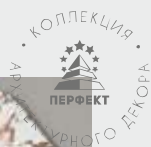

МОЛДИНГИ

ЭЛЕМЕНТЫ ДЕКОРА

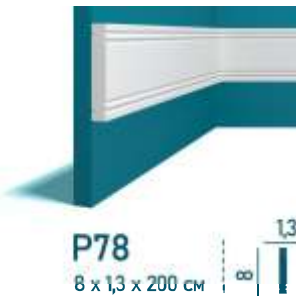
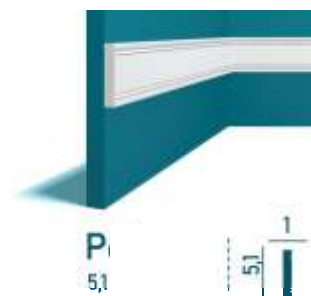



1. P 35

2. P 66

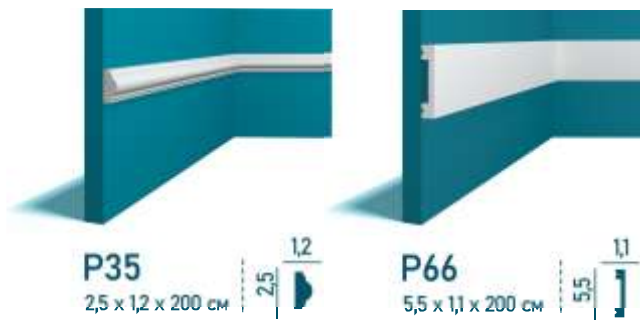

P35

2,5 x 1,2 x 200 cm



P66

5,5 x 1,1 x 200 cm

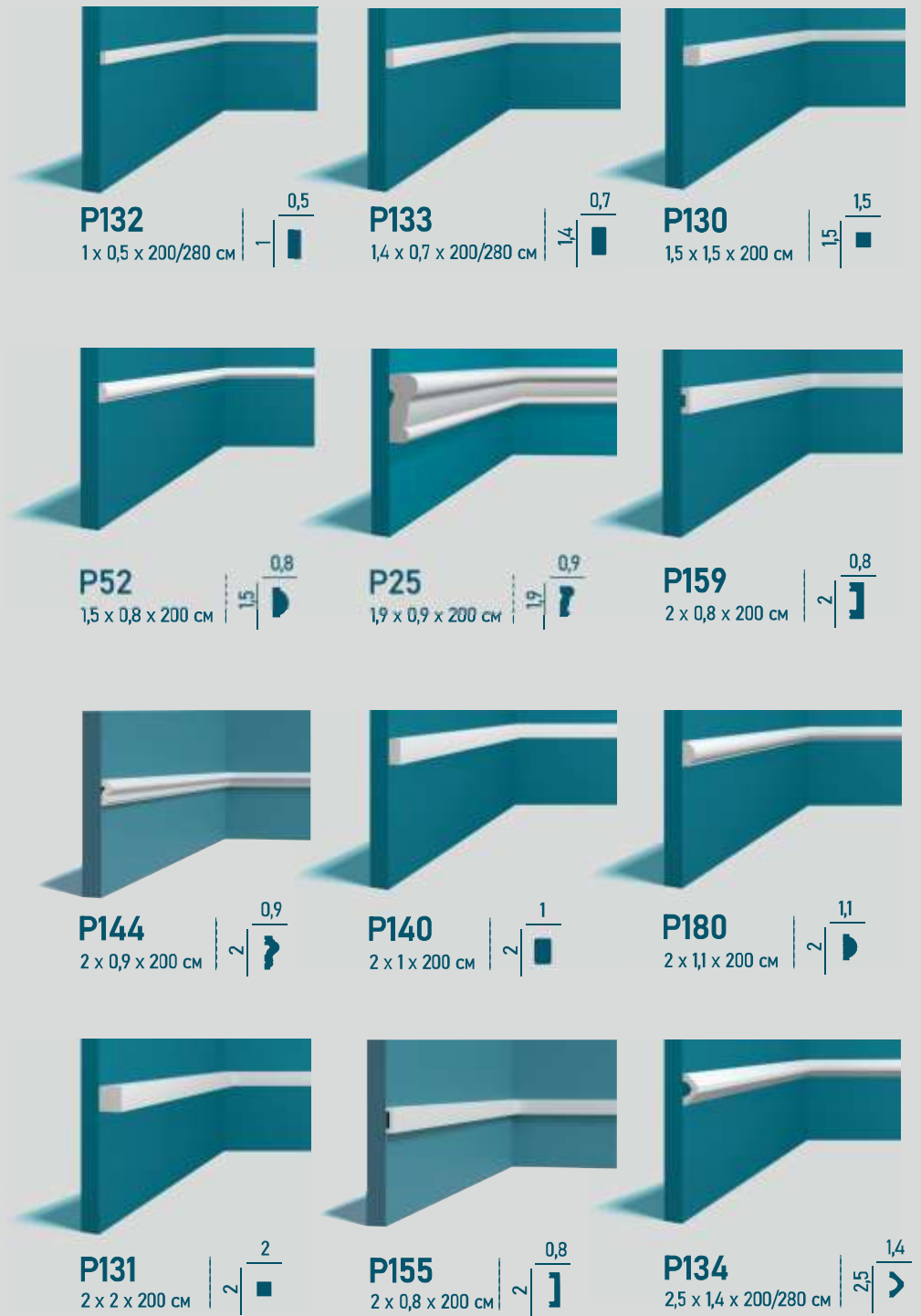

P132

1 x 0,5 x 200/280 cm



P133

1,4 x 0,7 x 200/280 cm



P130

1,5 x 1,5 x 200 cm



P52

1,5 x 0,8 x 200 cm



P25

1,9 x 0,9 x 200 cm



P159

2 x 0,8 x 200 cm



P144

2 x 0,9 x 200 cm



P140

2 x 1 x 200 cm



P180

2 x 1,1 x 200 cm



P131

2 x 2 x 200 cm



P155

2 x 0,8 x 200 cm



P134

2,5 x 1,4 x 200/280 cm





P35
2,5 x 1,2 x 200 cm



P35 FLEX
2,5 x 1,2 x 200 cm



P181
2,5 x 1,4 x 200 cm



P73
3,2 x 1 x 200 cm



P135
3,3 x 1,4 x 200/280 cm



P136
3,3 x 1,4 x 200/280 cm



P10
2,6 x 1,2 x 200 cm

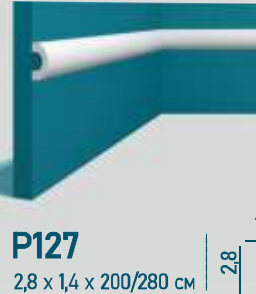

P127
2,8 x 1,4 x 200/280 cm



P160
3 x 0,8 x 200 cm



P137
3,3 x 1,4 x 200/280 cm



P138
3,3 x 1,4 x 200/280 cm



P76
3,5 x 2 x 200 cm



P123
3 x 1,4 x 200/280 cm



P77
3 x 1,1 x 200 cm



P145
3 x 1,1 x 200 cm

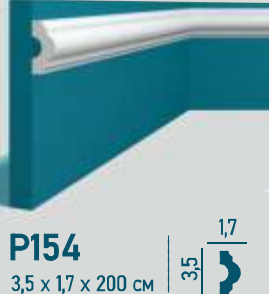

P154
3,5 x 1,7 x 200 cm



P178
3,5 x 2,7 x 200 cm



P23
3,7 x 1,6 x 200 cm



P53
3 x 1,3 x 200 cm



P71
3 x 2 x 200 cm



P179
3 x 2 x 200 cm

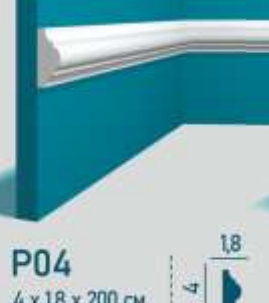

P04
4 x 1,8 x 200 cm

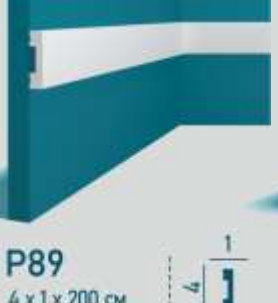

P89
4 x 1 x 200 cm



P139
4 x 2,5 x 200 cm

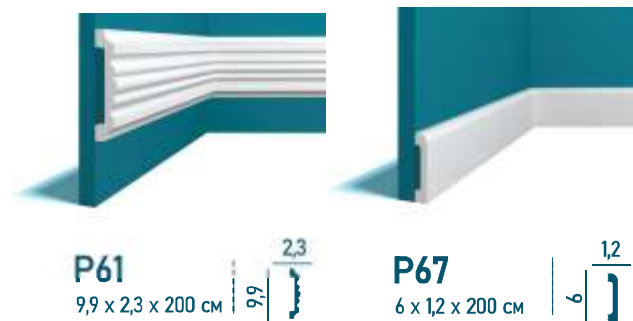
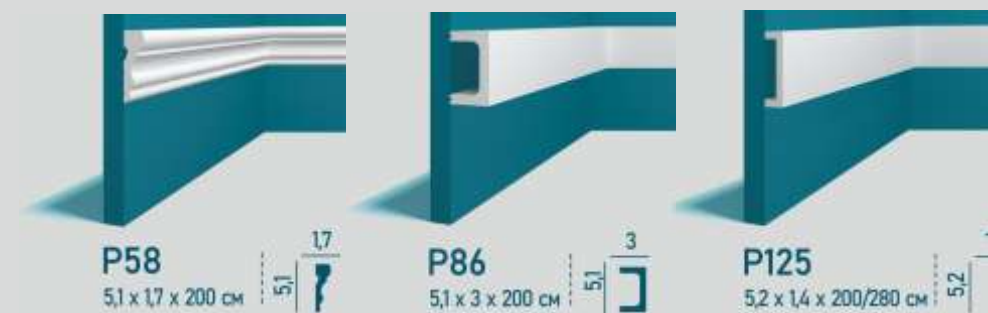
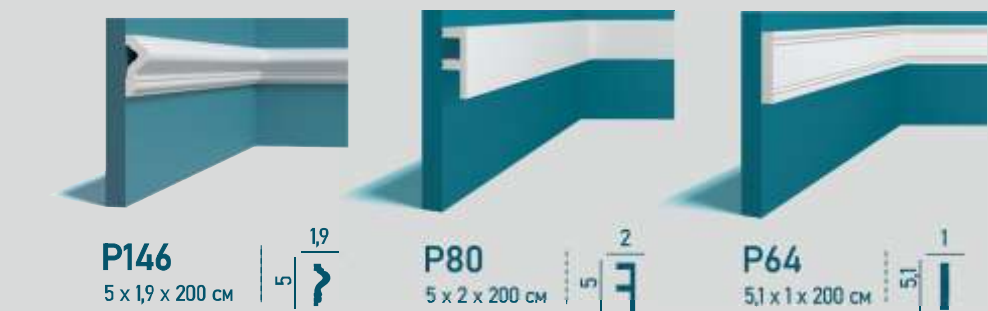
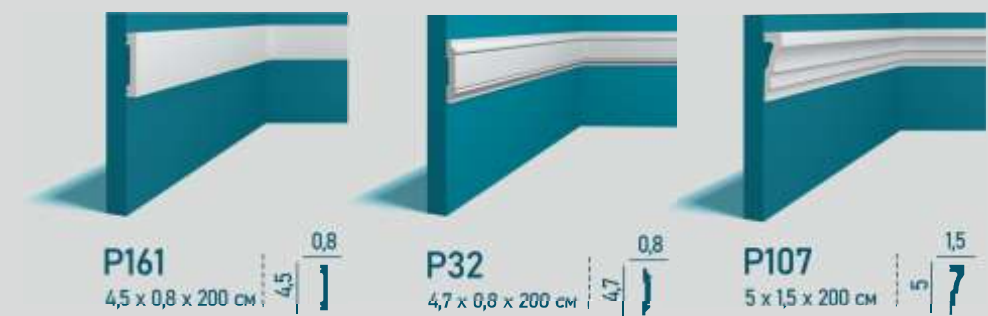
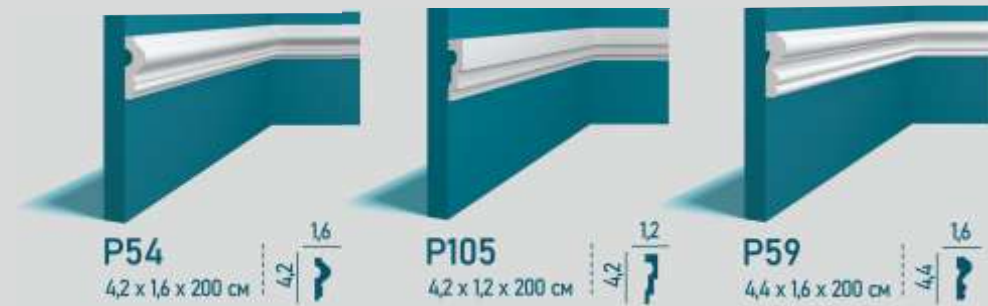



1. P 135



P135
3,3 x 1,4 x 200/280 cm | 33 | 1,4

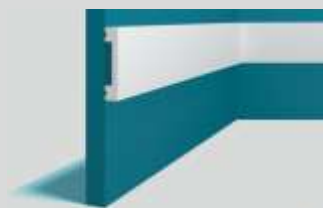

P66
5,5 x 1,1 x 200 cm | 5,5 | 1,1



P162
6 x 0,8 x 200 cm | 6 | 0,8



P60
6 x 2,6 x 200 cm | 6 | 2,6



P81
6,2 x 2,5 x 200 cm | 6,2 | 2,5



P33
6,5 x 1,5 x 200 cm | 6,5 | 1,5

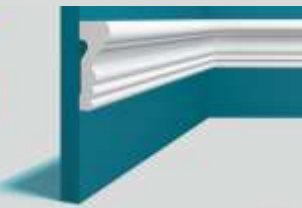

P55
6,8 x 2,6 x 200 cm | 6,8 | 2,6



P97
7 x 1,8 x 200 cm | 7 | 1,8



P01
7 x 1,9 x 200 cm | 7 | 1,9



P106
7 x 2 x 200 cm | 7 | 2



P163
7 x 0,8 x 200 cm | 7 | 0,8



P88
8 x 1,3 x 200 cm | 8 | 1,3



P78
8 x 1,3 x 200 cm | 8 | 1,3



P82
8 x 2,5 x 200 cm



P108
8 x 2,4 x 200 cm



P85
8,5 x 2,3 x 200 cm



P98
9 x 2,3 x 200 cm



P62
9,1 x 2,7 x 200 cm



P72
9,6 x 2,5 x 200 cm



P12
9,9 x 0,8 x 200 cm



P61
9,9 x 2,3 x 200 cm



P74
10 x 3,1 x 200 cm



P75
10,2 x 1,3 x 200 cm















P84
12 x 1,3 x 200 cm



Напольные плинтусы - выберите свой стиль!



ЭЛЕМЕНТЫ ДЕКОРА
**НАПОЛЬНЫЕ
 ПЛИНТУСЫ**

 P89 4 x 1 x 200 см 4 1	 P105 4,2 x 1,2 x 200 см 4,2 1,2	 P107 5 x 1,5 x 200 см 5 1,5
 P18 5,4 x 1,6 x 200 см 5,4 1,6	 P66 5,5 x 1,1 x 200 см 5,5 1,1	 P27 5,9 x 1,3 x 200 см 5,9 1,3
 P156 6 x 1,2 x 200 см 6 1,2	 P67 6 x 1,2 x 200 см 6 1,2	 P33 6,5 x 1,5 x 200 см 6,5 1,5
 P150 6,5 x 1,8 x 200 см 6,5 1,8	 P19 6,9 x 1,5 x 200 см 6,9 1,5	 P141 7 x 1,3 x 200 см 7 1,3



1. P 109



P109
11 x 1,6 x 200 cm



P157
7,5 x 1,4 x 200 cm



P01
7 x 1,9 x 200 cm



P40
7,8 x 2,3 x 200 cm



P29
7,9 x 1,3 x 200 cm



P29 FLEX
7,9 x 1,3 x 200 cm



P83
8 x 1,3 x 200 cm



P88
8 x 1,3 x 200 cm

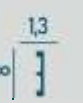

P116
8 x 1,2 x 200 cm



P151
8 x 2 x 200 cm



P48
8,2 x 1,1 x 200 cm



P49
8,2 x 1,3 x 200 cm



P47
8,2 x 1,3 x 200 cm





P174
8,5 x 1,6 x 200 см



P142
9 x 1,3 x 200 см



P111
9 x 1,4 x 200 см



P07
9,8 x 1,6 x 200 см



P12
9,9 x 0,8 x 200 см



P15
9,9 x 1,4 x 200 см



P41
9,9 x 2,1 x 200 см



P69
10 x 1,3 x 200 см



P56
10 x 1,5 x 200 см



P176
10 x 2,1 x 200 см



P75
10,2 x 1,3 x 200 см



P43
10,6 x 1,3 x 200 см



P115
18,3 x 1,5 x 200 см



P45
10,6 x 2,5 x 200 см | 10,6 | 2,5



P112
11 x 1,5 x 200 см | 11 | 1,5



P109
11 x 1,6 x 200 см | 11 | 1,6



P31
13,8 x 2,0 x 200 см | 13,8 | 2,0



P63
15,0 x 2,2 x 200 см | 15 | 2,2



P113
16 x 1,5 x 200 см | 16 | 1,5



P14
11,8 x 1,5 x 200 см | 11,8 | 1,5



P84
12 x 1,3 x 200 см | 12 | 1,3



P68
12 x 1,3 x 200 см | 12 | 1,3



P118
16 x 1,8 x 200 см | 16 | 1,8



P114
18 x 1,8 x 200 см | 18 | 1,8



P115
18,3 x 1,5 x 200 см | 18,3 | 1,5



P70
12 x 1,3 x 200 см | 12 | 1,3



P152
12,5 x 2,1 x 200 см | 12,5 | 2,1



P50
12,6 x 1,6 x 200 см | 12,6 | 1,6



P175
20 x 2,3 x 200 см | 20 | 2,3



P117
13 x 1,2 x 200 см | 13 | 1,2



P158
13 x 1,5 x 200 см | 13 | 1,5



P110
13 x 1,8 x 200 см | 13 | 1,8

Углы и угловые элементы – создавайте уникальные интерьерные решения



ЭЛЕМЕНТЫ ДЕКОРА

УГЛЫ И УГЛОВЫЕ ЭЛЕМЕНТЫ



P11
2 x 2 x 200 см



P06
3 x 3 x 200 см



P20
3 x 3 x 200 см



P35-1
11,5 x 11,5 x 1,2 см



P04-1
16,5 x 16,5 x 1,8 см













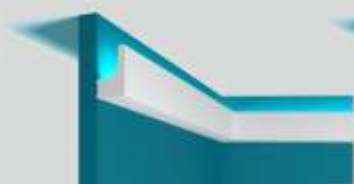

P54-1
20,5 x 20,5 x 1,6 см

Профили для скрытого освещения превратят ваш дом в дом мечты, отражающий вашу личность



ЭЛЕМЕНТЫ ДЕКОРА

ПРОФИЛИ ПОД ПОДСВЕТКУ

 <p>P87 4 x 2,5 x 200 см</p>  <p>P22 4,2 x 2,9 x 200 см</p>  <p>P80 5 x 2 x 200 см</p>
 <p>P95 5 x 3,1 x 200 см</p>  <p>P93 6 x 3,2 x 200 см</p>  <p>P81 6,2 x 2,5 x 200</p>
 <p>P96 6,8 x 4,6 x 200 см</p>  <p>P94 7,9 x 6 x 200 см</p>  <p>P82 8 x 2,5 x 200 см</p>
 <p>P92 8 x 4,3 x 200 см</p>  <p>P90 9,7 x 5 x 200 см</p>  <p>P79 10 x 5,5 x 200 см</p>



1. P 95

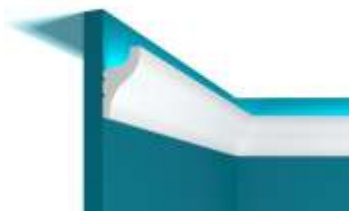

P95
5 x 3,1 x 200 cm



P99
10 x 10 x 200 cm



P91
12 x 5,5 x 200 cm

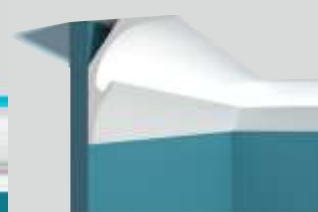

P177
12 x 9 x 200 cm

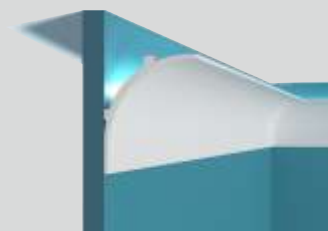

P149
12 x 10 x 200 cm

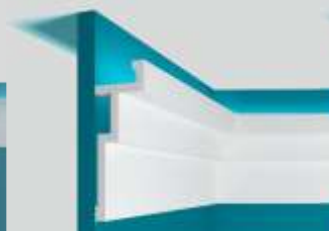

P101
13 x 4,5 x 200 cm



P100
13 x 13 x 200 cm



P176
10 x 2,1 x 200 cm



Дверное обрамление - придайте своим дверям классическое изящество



ЭЛЕМЕНТЫ ДЕКОРА

ДВЕРНОЕ ОБРАМЛЕНИЕ



P66
5,5 x 1,1 x 200 см



P162
6 x 0,8 x 200 см



P67
6 x 1,1 x 200 см



P33
6,5 x 1,5 x 200 см



P55
6,8 x 2,6 x 200 см



P97
7 x 1,8 x 200 см



P106
7 x 2 x 200 см



P01
7 x 2,6 x 200 см



P163
7,5 x 0,8 x 200 см



P116
8 x 1,2 x 200 см



P108
8 x 2,4 x 200 см



P78
8 x 1,3 x 200 см



P83
8 x 1,3 x 200 cm | 8 } ^{1,3}/₁



P88
8 x 1,3 x 200 cm | 8 } ^{1,3}/₁



P85
8,5 x 2,3 x 200 cm | 8,5 } ^{2,3}/₇



P98
9 x 2,3 x 200 cm | 9 } ^{2,3}/₇



P62
9 x 2,3 x 200 cm | 9 } ^{2,3}/₇



P72
9,6 x 2,5 x 200 cm | 9,6 } ^{2,5}/₇



P61
9,9 x 2,3 x 200 cm | 9,9 } ^{2,3}/₇



P69
10 x 1,3 x 200 cm | 10 } ^{1,3}/₁



P74
10 x 3,8 x 200 cm | 10 } ^{3,8}/₇



P75
10,2 x 1,3 x 200 cm | 10,2 } ^{1,3}/₁



P109
11 x 1,6 x 200 cm | 11 } ^{1,6}/₁



P68
12 x 1,3 x 200 cm | 12 } ^{1,3}/₁



P110
13 x 1,8 x 200 cm | 13 } ^{1,8}/₁

3D панели - создавайте
уникальные интерьерные решения



ЭЛЕМЕНТЫ ДЕКОРА

3D ПАНЕЛИ

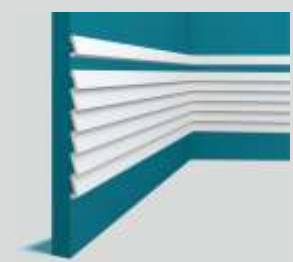
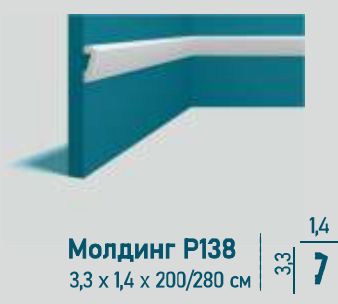

Панель P119 + Молдинг P138



P121

20 x 1,4 x 200/280 см

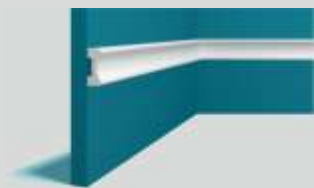
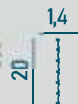

Молдинг P136

3,3 x 1,4 x 200/280 см

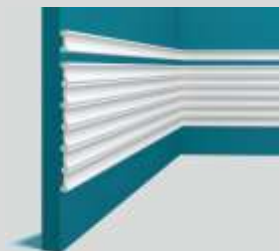

Панель P121 + Молдинг P136

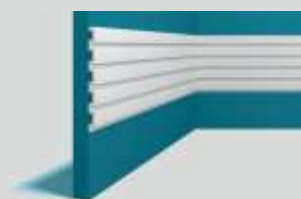

P122

20 x 1,4 x 200/280 см



Молдинг P138

1 x 0,5 x 200/280 см



Молдинг P128

3 x 1,4 x 200/280 см

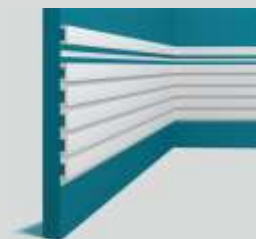

Панель P122 + Молдинг P138 + Молдинг P128



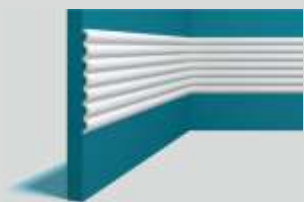

P126

20 x 1,4 x 200/280 см

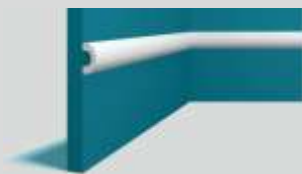

Молдинг P127

2,8 x 1,3 x 200/280 см

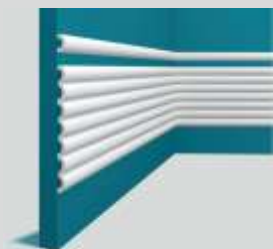

Панель P126 + Молдинг P127

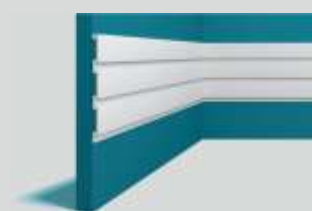

P124

20 x 1,4 x 200/280 см

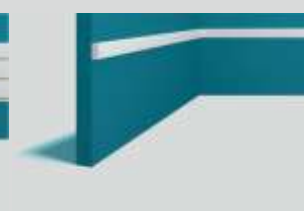

Молдинг P133

1,4 x 0,7 x 200/280 см



Молдинг P125

5,2 x 1,4 x 200/280 см

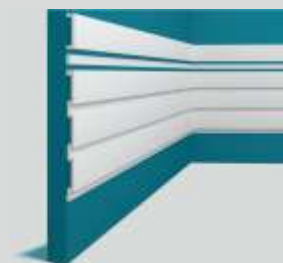

Панель P124 + Молдинг P133 + Молдинг P125





P128

20 x 1,4 x 200/280 см



Молдинг P134

2,5 x 1,4 x 200/280 см

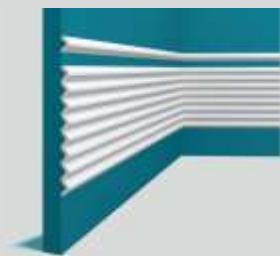

Панель P128 + Молдинг P134

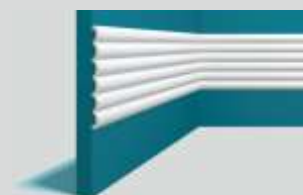
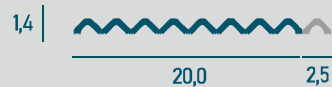

P129

20 x 1,4 x 200/280 см



Молдинг P135

3,3 x 1,4 x 200/280 см

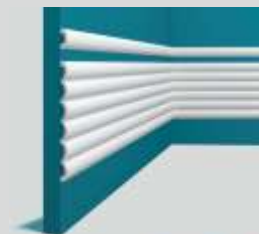

Панель P129 + Молдинг P135

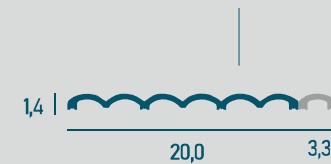



P165

20 x 1,4 x 200/280 cm



P166

20 x 1,4 x 200/280 cm



P167

20 x 1,4 x 200/280 cm



P168

20 x 1,4 x 200/280 cm



P169

20 x 1,4 x 200/280 cm





P170

20 x 1,4 x 200/280 cm



P171

20 x 1,4 x 200/280 cm



1. P 170

2. P 171



P172

20 x 1,4 x 200/280 cm



P173

20 x 1,4 x 200/280 cm



1. P 172

2. P 173

Клей

(Для монтажа изделий «Перфект Плюс»)

КЛЕЙ МОНТАЖНЫЙ ПЕРФЕКТ ПЛЮС



Обладает повышенной силой первичного схватывания.

Для внутренних и наружных работ с любыми видами декоративных изделий из полиуретана и полистирола, камня, кафеля, гипса, дерева, эксплуатируемых во влажных и сухих помещениях.

- цвет белый
- экологически безопасен
- морозостойкий
- сила первичного схватывания 150 кг/м²
- объём катриджа 310 мл
- расход клея 7-8 п.м.
- температура применения +5 С до +25 С.

КЛЕЙ СТЫКОВОЧНЫЙ ПЕРФЕКТ ULTRA FIX



Клей сверхбыстрой фиксации на основе этил-цианакрилата для склеивания деталей архитектурного декора из полиуретана и полимера высокой плотности между собой.

Фиксация происходит от 2 до 5 минут. Для внутренних и наружных работ.

- цвет прозрачный
- предназначен для склеивания стыков
- морозостойкий
- объём тюбика 100мл
- расход клея 45-55 п.м.
- температура применения +5 С до +30 С.

КЛЕЙ СТЫКОВОЧНЫЙ ПЕРФЕКТ



Клей сильной фиксации на основе полиуретана для склеивания деталей архитектурного декора из полиуретана и полимера высокой плотности между собой.

Для внутренних и наружных работ.

- цвет полупрозрачный
- предназначен для склеивания стыков
- морозостойкий
- объём тюбика 50мл
- расход клея 20-25 п.м.
- температура применения +5 С до +35 С.

КЛЕЙ ПЕРФЕКТ «КЛЕЙ-ШПАТЛЁВКА»



Клей-шпатлёвка применяется для работ с любыми видами декоративной лепнины из полиуретана и полистирола. Благодаря своим сильным клеящим свойствам может применяться при работе с камнем, кафелем, гипсом, деревом, эксплуатируемых во влажных и сухих помещениях. Может применяться, как шпатлёвка для заполнения зазоров между плинтусом/розеткой и поверхностью стены/потолка.

- цвет белый
- экологически безопасен
- морозостойкий
- сила первичного схватывания 55 кг/м²
- объём катриджа 310 мл
- расход клея 7-8 п.м.
- температура применения +5 С до +25 С.

Монтаж

Архитектурный декор «ПЕРФЕКТ ПЛЮС» изготовлен на самом современном европейском оборудовании из полимера высокой плотности. Это прочный, экологичный материал, с четкой геометрией, легко окрашивается и абсолютно влагостойкий.

Общие рекомендации:



До установки изделия не менее 24 часов в помещении, где будет производиться установка. Работы рекомендуется проводить при температуре воздуха 15-25 С, влажность 40-70%.



Стены, потолок и изделия должны быть сухими и чистыми.



Крепить изделия необходимо на предварительно выровненные и загрунтованные поверхности.



Количество и метраж изделий необходимо рассчитывать с учетом потерь, возникающих при срезании углов (примерно 10% от общей длины изделий).



Покраску стен и потолков, а также оклейку обоями следует производить после монтажа изделий

Инструкция по монтажу

1

Рулеткой отмерьте необходимый размер изделия.



2

Отпилите фрагмент изделия требуемой длины с помощью стусла и ножовки с мелким зубом или торцовочной пилы.



3

Нанесите монтажный клей по всей длине изделия.

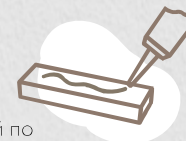

4

На торец изделия нанесите стыковочный клей.



5

Прижмите изделие к стене и в сторону стыка со следующим изделием. Шпателем снимите излишки клея.



6

При необходимости зафиксируйте приклеиваемое изделие на стене с помощью гвоздиков до полного отверждения клея.



7

Зачистите место стыка наждачной бумагой и зашпаклюйте отверстия от гвоздиков.



8

Теперь можно окрашивать.



Необходимые инструменты



Постраничный указатель

P01	19, 25,37	P43	26
P02	5	P44	8
P03	9	P45	28
P04	15	P46	8
P05	7	P47	25
P06	31	P48	25
P07	26	P49	25
P08	8	P50	28
P09	5	P51	5
P10	14	P52	13
P11	31	P53	14
P12	20, 26	P54	17
P13	7	P55	19, 37
P14	28	P56	26
P15	26	P57	8
P16	9	P58	17
P17	8	P59	17
P18	23	P60	19
P19	23	P61	16, 20, 38
P20	31	P62	20, 38
P21	7	P63	29
P22	7, 33	P64	11, 17
P23	15	P65	5
P24	5	P66	12, 19, 23, 37
P25	13	P67	16, 23, 37
P26	5	P68	28,38
P27	23	P69	26, 38
P28	7	P70	28
P29	25	P71	14
P29 flex	25	P72	20, 38
P30	8	P73	15
P31	29	P74	20,38
P32	17	P75	20, 26, 38
P33	19,23, 37	P77	14
P34	5	P78	11, 19, 37
P35	12,14	P79	8, 33
P35 flex	14	P80	17, 33
P35-1	31	P81	19, 33
P36	5	P82	20, 33
P37	5	P83	25, 38
P38	5	P84	20, 28
P39	7	P85	20, 38
P40	25	P86	17
P41	26	P87	5, 33
P42	7	P88	19, 25, 38

P89	15,23
P90	8, 33
P91	9, 35
P92	8, 33
P93	7, 33
P94	8, 33
P95	7, 33, 34
P96	8, 33
P97	19, 37
P98	20, 38
P99	9, 35
P100	9, 35
P101	9, 35
P102	9
P103	9
P104	9
P105	17, 23
P106	19, 37
P107	17, 23
P108	20, 37
P109	24, 28, 38
P110	28, 39
P111	26
P112	28
P113	29
P114	29
P115	27, 29
P116	25, 37
P117	28
P118	29
P119	41
P121	42
P122	43
P123	14
P124	45
P125	17, 45
P126	44
P127	14, 44
P128	43, 46
P129	47
P130	13
P131	13
P132	13
P133	13, 45
P134	13, 46
P135	15, 18, 47

P136	15, 42
P137	15
P138	15, 41, 43
P139	15
P140	13
P141	23
P142	26
P143	8
P144	13
P145	14
P146	17
P147	7
P148	7
P149	9, 35
P150	23
P151	25
P152	28
P153	7
P155	13
P156	23
P157	25
P158	28
P159	13
P160	14
P161	17
P162	19,37
P163	19, 37
P164	5
P165	48
P166	48
P167	48
P168	49
P169	49
P170	50
P171	50
P172	51
P173	51
P174	26
P175	29
P176	26, 35
P177	9, 35
P179	14
P180	13
P181	14

1. P 165

2. P 122

3. P 166

4. P 167



